

COOK CONCRETE PRODUCTS, INC.

—Precast—



MANHOLE PIPE • DRAINAGE INLETS • STORM WATER/OIL INTERCEPTORS • UTILITY VAULTS & BOXES • CUSTOM PRECAST

(530) 243-2562
FAX (530) 243-6881
www.cookconcreteproducts.com
e-mail:
Info@cookconcreteproducts.com

5461 EASTSIDE ROAD
P.O. BOX 720280
REDDING, CA 96099

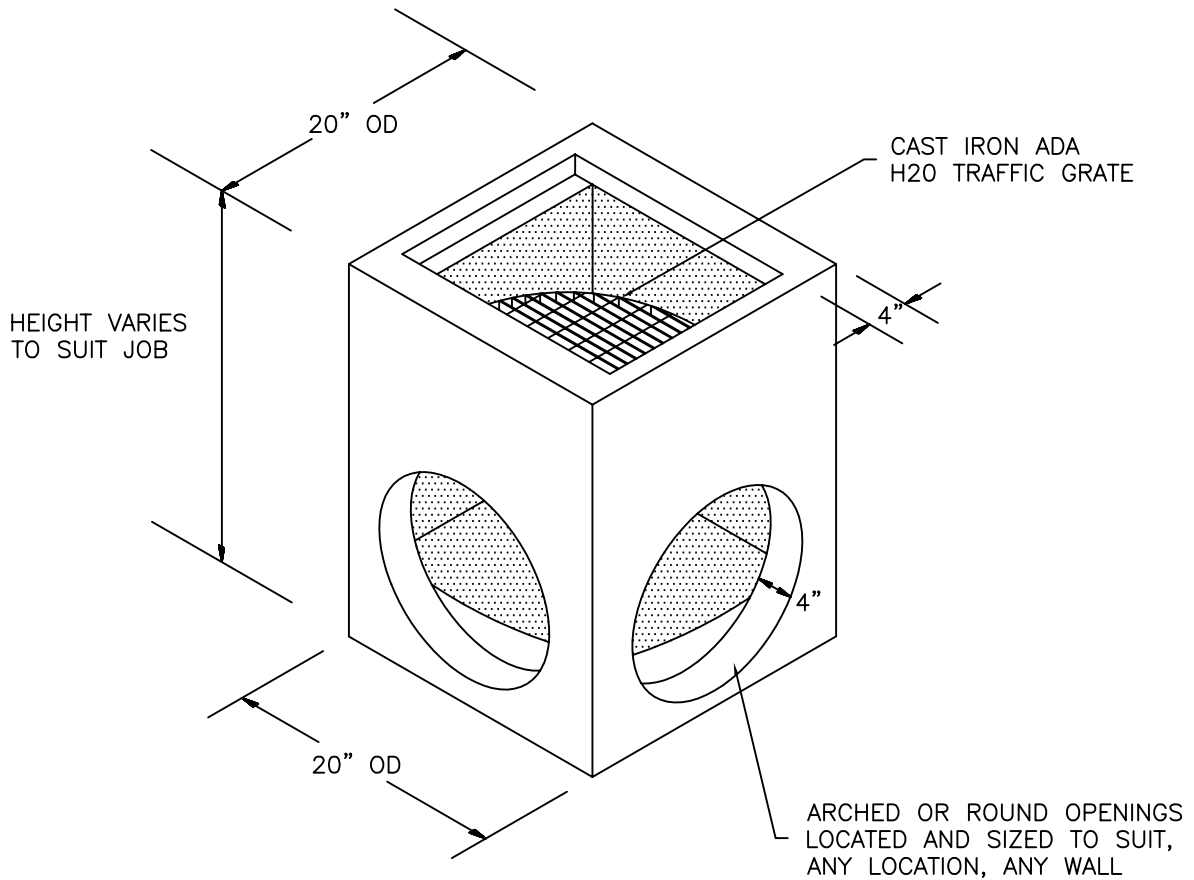

NOTES:

1. CONCRETE COMPRESSIVE STRENGTH
4000 PSI AT 28 DAYS, REINFORCED FOR
H-20 LOADING
2. UNITS ARE CUSTOM MADE FOR EACH JOB
3. AVAILABLE WITH OR WITHOUT BOTTOM
4. OPENINGS ARE SIZED AND LOCATED PER PLAN
5. WEIGHT WITHOUT BASE 265LBS./FT

12" x 12" CATCH BASIN