

# COOK CONCRETE PRODUCTS, INC.

—Precast—



MANHOLE PIPE • DRAINAGE INLETS • STORM WATER/OIL INTERCEPTORS • UTILITY VAULTS & BOXES • CUSTOM PRECAST

(530) 243-2562  
FAX (530) 243-6881  
www.cookconcreteproducts.com  
e-mail:  
Info@cookconcreteproducts.com

5461 EASTSIDE ROAD  
P.O. BOX 720280  
REDDING, CA 96099

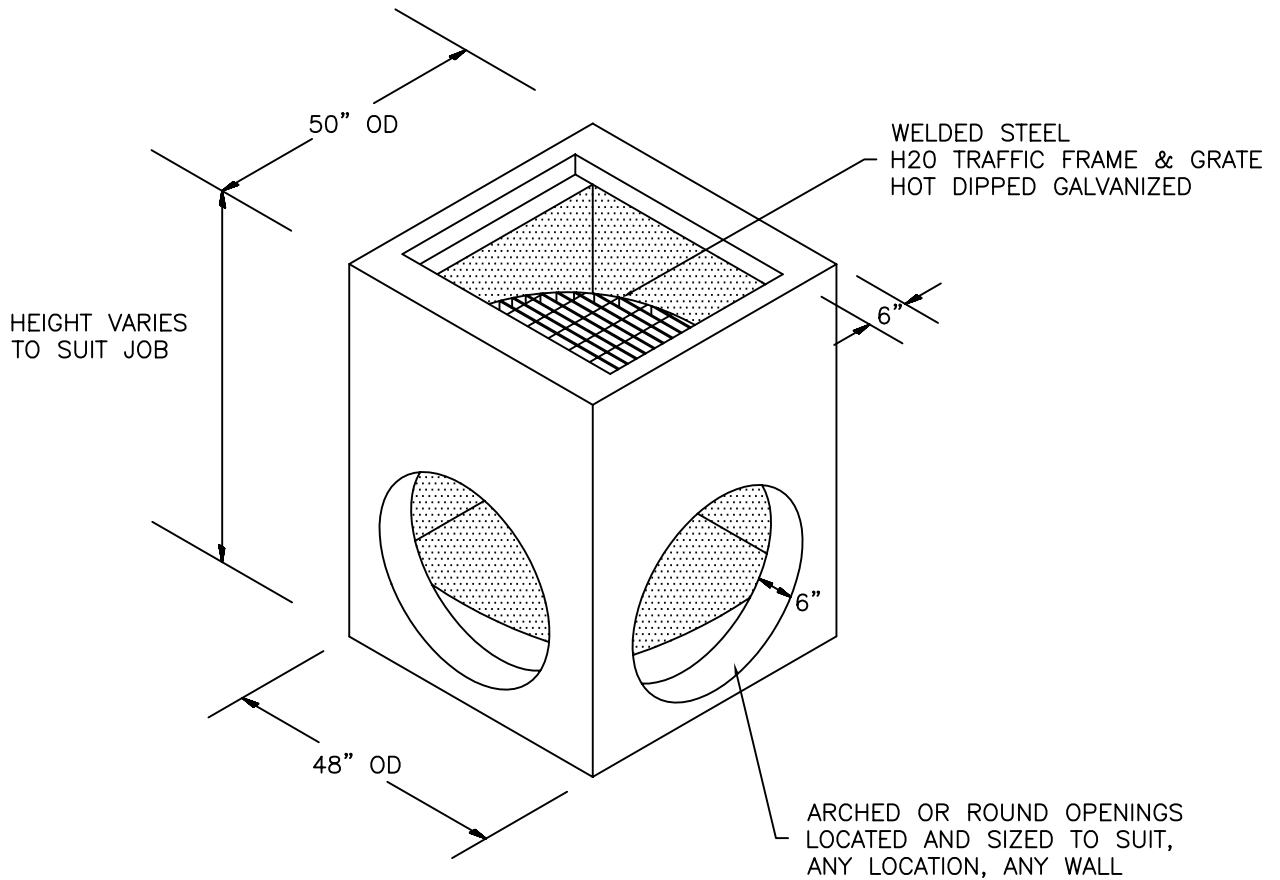

NOTES:

1. CONCRETE COMPRESSIVE STRENGTH  
4000 PSI AT 28 DAYS, REINFORCED FOR  
H-20 LOADING
2. UNITS ARE CUSTOM MADE FOR EACH JOB
3. AVAILABLE WITH OR WITHOUT BOTTOM
4. OPENINGS ARE SIZED AND LOCATED PER PLAN
5. WEIGHT WITHOUT BASE 265LBS./FT

36" x 36" CATCH BASIN