

COOK CONCRETE PRODUCTS, INC.

—Precast—



MANHOLE PIPE • DRAINAGE INLETS • STORM WATER/OIL INTERCEPTORS • UTILITY VAULTS & BOXES • CUSTOM PRECAST

(530) 243-2562
FAX (530) 243-6881
www.cookconcreteproducts.com
e-mail: Info@cookconcreteproducts.com

5461 EASTSIDE ROAD
P.O. BOX 720280
REDDING, CA 96099

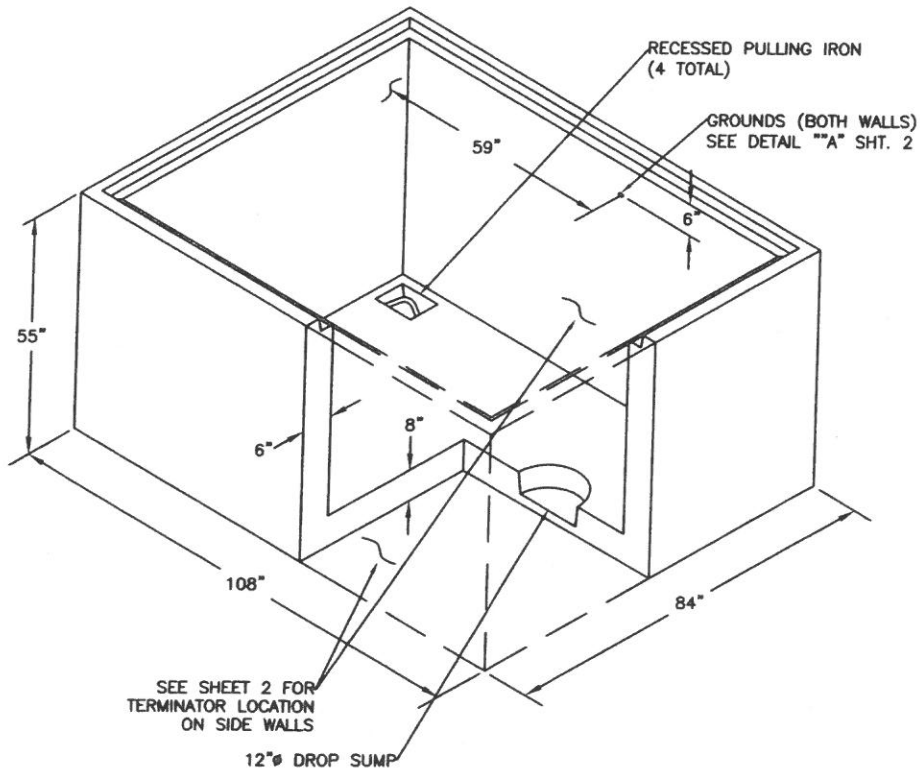
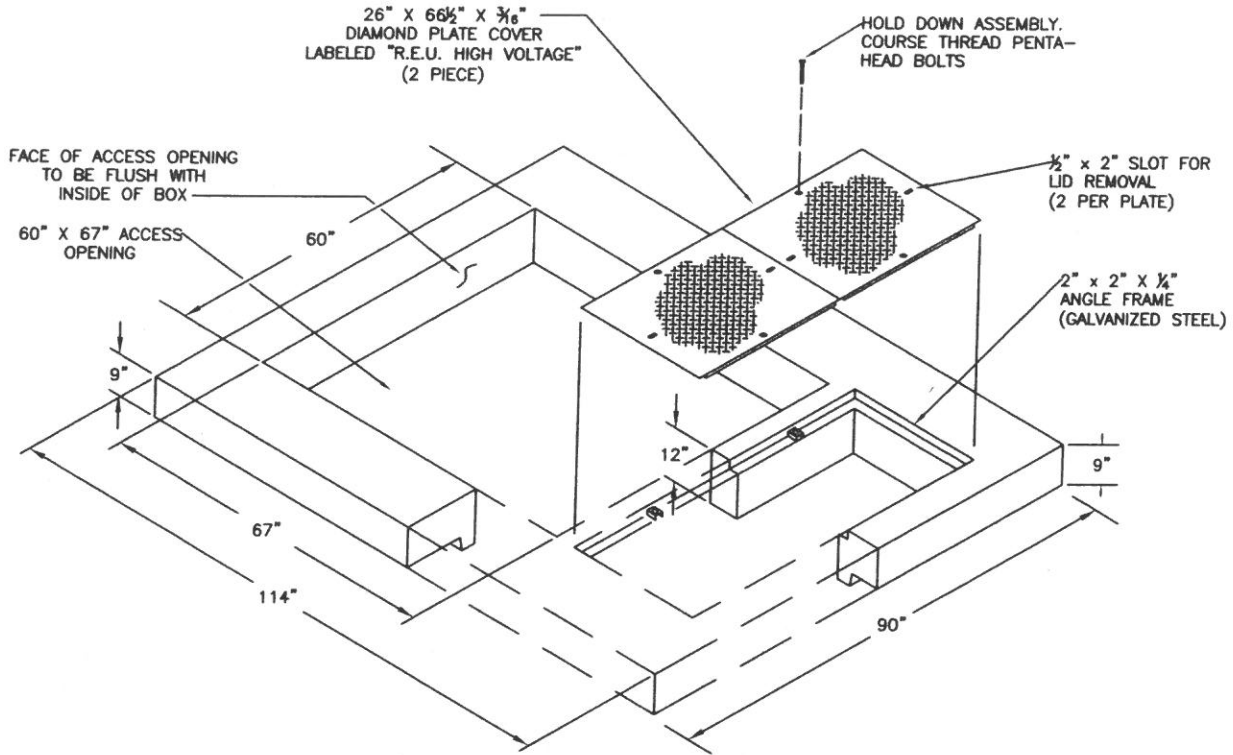

R.E.U. SWITCH VAULT

COOK CONCRETE PRODUCTS, INC.

—Precast—



MEMBER OF

NPCA

Precast...The Concrete Solution

MANHOLE PIPE • DRAINAGE INLETS • STORM WATER/OIL INTERCEPTORS • UTILITY VAULTS & BOXES • CUSTOM PRECAST

(530) 243-2562
 FAX (530) 243-6881
 www.cookconcreteproducts.com
 e-mail: Info@cookconcreteproducts.com

5461 EASTSIDE ROAD
 P.O. BOX 720280
 REDDING, CA 96099

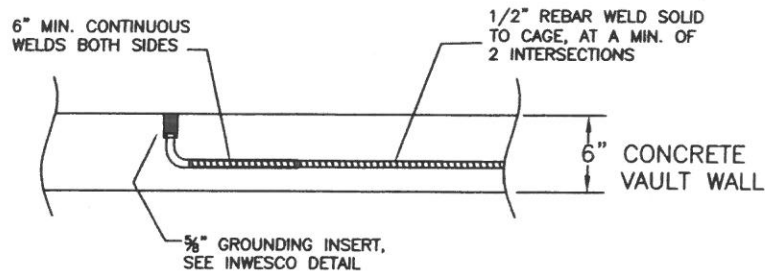
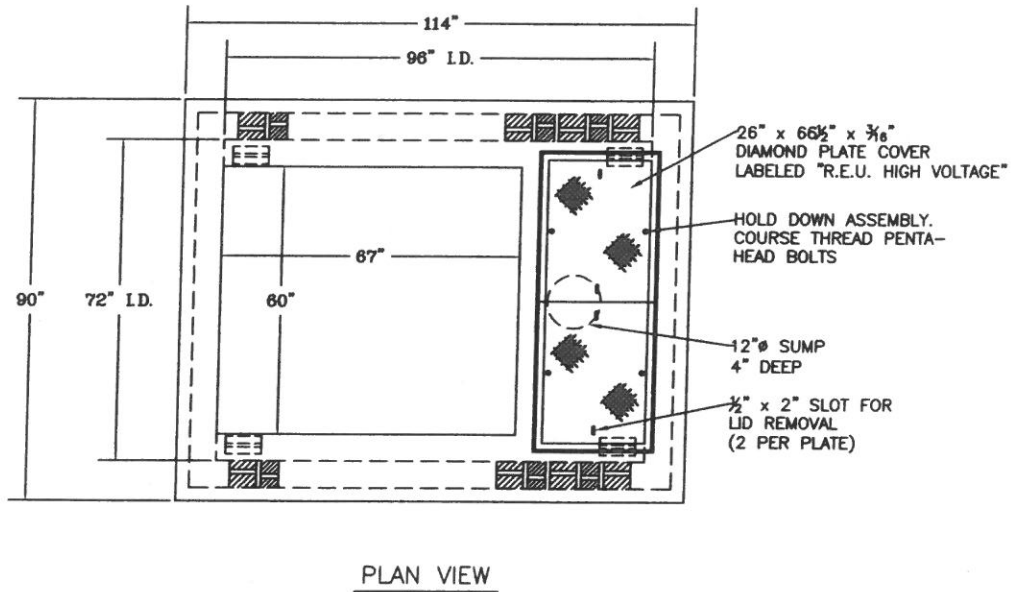
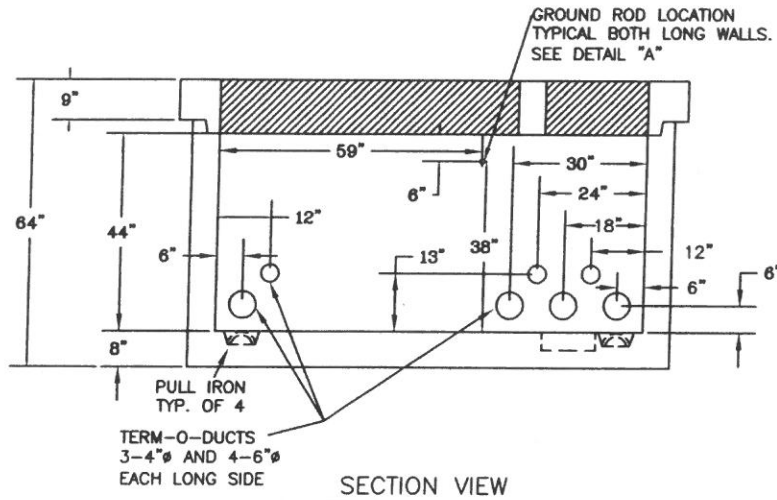

COOK CONCRETE PRODUCTS, INC.

—Precast—



MEMBER OF

NPCA

Precast ...The Concrete Solution

MANHOLE PIPE • DRAINAGE INLETS • STORM WATER/OIL INTERCEPTORS • UTILITY VAULTS & BOXES • CUSTOM PRECAST

(530) 243-2562
FAX (530) 243-6881
www.cookconcreteproducts.com
e-mail: Info@cookconcreteproducts.com

5461 EASTSIDE ROAD
P.O. BOX 720280
REDDING, CA 96099

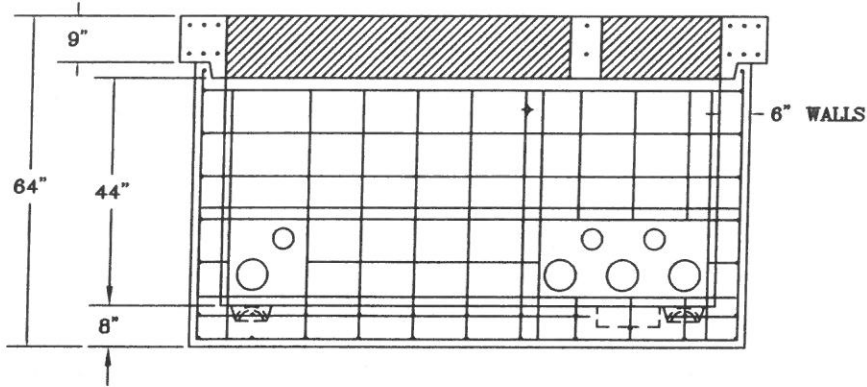

SECTION VIEW

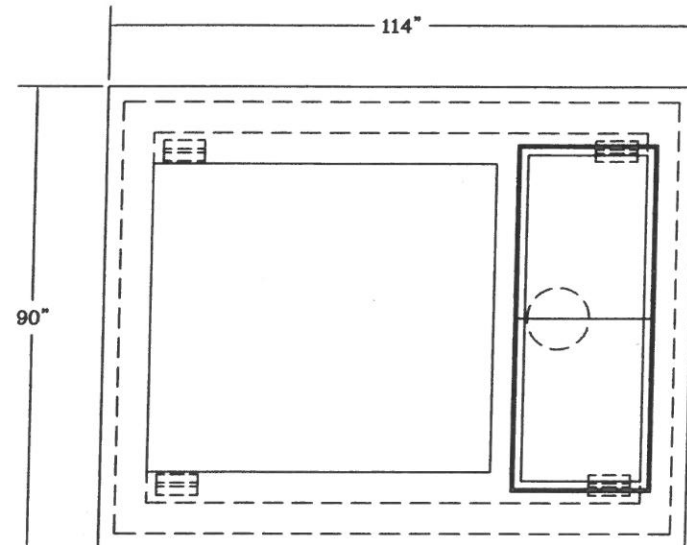

PLAN VIEW

6' X 8' SWITCH VAULT